

# ENP-2120B

• **200W**



## Features

- SFX12V Rev. 2.2 & SFX Backward Compliant
- High Efficiency
- Remote On/Off
- Power good TTL Signal
- Short Circuit, Over Current & Voltage Protection
- IAPC, Wake-On-LAN Technology Ready
- Auto-Sensing Thermal Control
- Low Acoustic Noise

## Apply For

- All Intel Processors up to P4
- All AMD Processors up to Athlon



## Electrical Specifications

- Input Voltage 100 ~ 127 VAC  
200 ~ 240 VAC  
Manual Select
- Frequency 47 ~ 63 Hz
- Input current 5.0 Arms @ 115 VAC  
3.0 Arms @ 230 VAC
- Holdup Time > 14 ms @ Full Load

## Environmental Specifications

- Operating/Storage Temp. 10~50°C/-20~60°C
- Operating/Storage Humidity 85% / 95%
- Operating/Storage Altitude 10,000/50,000 FT
- MTBF 100,000 HRS
- EMC Regulations FCC, CE

## Output Specifications

Voltage	Regulation Load	Minimum Load	Maximum Load	Peak
+3.3V	+5%, -3%	1.0A	17.0A	--
+5.0V	+/- 5%	3.0A	21.0A	--
+12.0V	+/- 5%	1.0A	13.0A	--
-12.0V	+/- 10%	0A	0.8A	--
+5 Vsb	+/- 5%	0A	2.0A	--

(\* Total maximum combines load output on +3.3V and +5V rails is 130 Watts.

SFX12V

# ENP-2120B

• 200W

## Mechanical Drawing

SFX12V

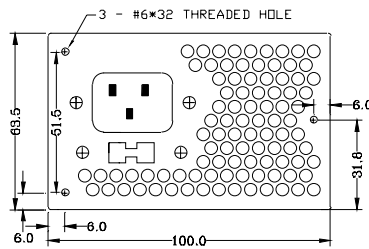
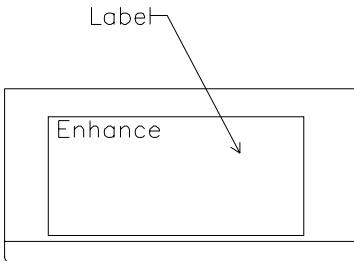
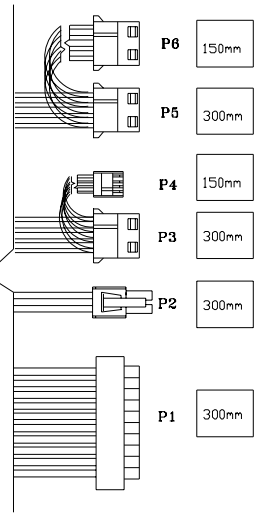
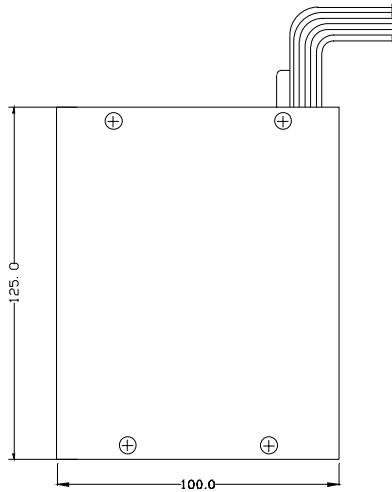
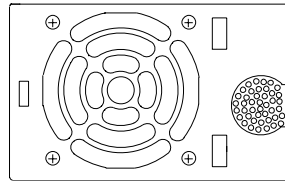

# ENP-2120B

## Wire Harness

• **200W**

### Description

P1 - Main Power

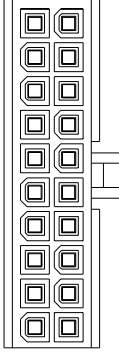

P2 - 4 Pin Processor Power

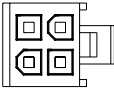

P3, P5 to P6- Peripheral



P4 - Floppy

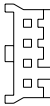

### Connector Housing

Molex 39-01-2200 or Equivalent

1	Orange	+3.3V	11	Orange	+3.3V
2	Orange	+3.3V	12	Blue	-12VDC
3	Black	GND	13	Black	GND
4	Red	+5V	14	Green	PS_ON
5	Black	GND	15	Black	GND
6	Red	+5V	16	Black	GND
7	Black	GND	17	Black	GND
8	Gray	PWR OK	18	White	-5V
9	Purple	5 VSB	19	Red	+5V
10	Yellow	+12V	20	Red	+5V

Molex 39-01-2040 or Equivalent

1	Black	GND	3	Yellow	+12V
2	Black	GND	4	Yellow	+12V

Molex 8981-04P or Equivalent

1	Yellow	+12V
2	Black	GND
3	Black	GND
4	Red	+5V

AMP 171822-4 or Equivalent

1	Red	+5V
2	Black	GND
3	Black	GND
4	Yellow	+12V

### Dimension (WxLxH)

- 100 x 125 x 63.5 (mm)
- 3.93 x 4.92 x 2.5 (inch)

### Cooling Fan

- 12V DC, 60 mm

### Notes

- Specification subject to change without notice. All new processors support will be updated once official announced by vendors
- All company logo and legal name belong to original company. All copyright reserved by Enhance Electronics.
- One-Year Standard Warranty
- Last Update: 8/31/2009

SFX12V